



Peter Besant  
24 Searle Way  
Eight Ash Green  
Colchester  
Essex  
CO6 3QS  
Tel – 07747 018544  
[www.prmrp.com](http://www.prmrp.com)

## **BR 58' GUV**

### **Building Instructions**

**SCALE MODEL PRODUCT FOR ADULT MODELLERS ONLY.  
WHITE METAL CONTAINS LEAD WASH HANDS AFTER USE.  
MAY CONTAIN SMALL PARTS. ETCHED BRASS HAS FUNCTIONAL SHARP EDGES  
- HANDLE WITH EXTREME CARE**

Thank you for purchasing this kit.

This instruction pack should provide guide for building this model given some experience of soldering and the basics of etched kit construction. Please note that the body is only basically shaped as the final profile can only be established whilst soldering the coach ends in place.

Please read all the pack before starting to build.

Drawings and photos are essential for builders to acquaint themselves with the prototype they wish to model.

For builders of modern image in 7mm, consider joining MIGO+1, the Modern Image Gauge 0/1 organisation.

Transfers are available from Fox Transfers.

# BR 58' GUV.

NKV Kit. - This kit makes the standard Vac. Fitted/Steam Piped GUV - with B.I. Modified bogies. It also makes the NJ Electric Wired Version by fitting ETH Jumpers. In this guise it can be made as a Vacuum Braked/Dual or Air Braked Van.

The NL Version can be made by fitting ETH Gear. This is a Vac. Braked Newspaper Van, and is not to be confused with the NLX - which is a different vehicle NOT covered by this kit.

You can also model The NX Motorail Version by again fitting ETH Gear. These vehicles are either Dual or Air-Braked & are beginning to appear in Blue/Grey Livery.

All very confusing - you can get all the latest info. by buying the Platform Five Pocket Book on Coaching Stock published twice a year.

## USE PMP COACH WAGON SCREW COUPLINGS.

Other Optional Packs from PMP range of DE-LUXE fittings -

1. Sprung Coach Buffers.
2. Working Vac. Pipes.
3. Working Steam Heat Pipes.
4. Working Air Pipes (if applicable)
5. Working ETH Gear (if applicable)

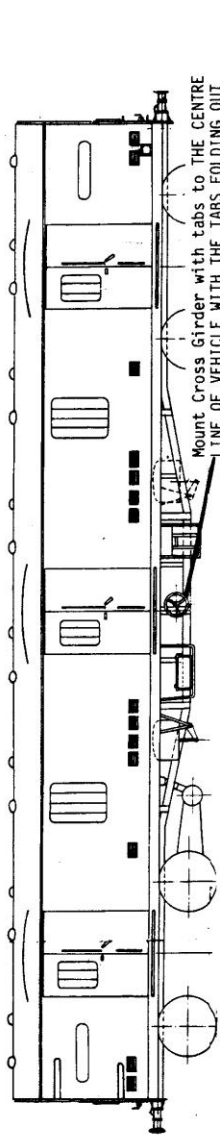

Mount Cross Girder with tabs to the CENTRE LINE OF VEHICLE WITH THE TABS FOLDING OUT AWAY FROM THE DYNAMO END OF THE VEHICLE. Pass brass rod through these tabs to the width of the solebars & solder the Etched Handbrake Wheels to each end of the rod.

Fit Vents/Upright Sections of RainStrips to Roof.

Add Etched Beading to top edge of van body.

Fold Up Window Bar Frames & fit behind all windows. Bars should be made from wire.

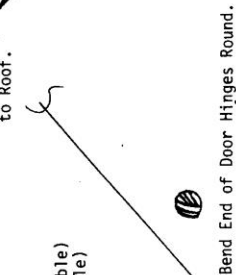

Fold Up Window Bar Frames & fit behind all windows. Bars should be made from wire.

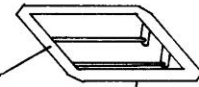

Main Door Clasp Etching - fold handle outwards

Fit Door Stops using pins provided.

Fit 4 Etched Destination States to etched frames - 3 holes are provided to assist in soldering from behind.

Fold & Fit etched Load Consist Clips into 1/2 etched recesses in lower right hand of body sides. (SHOWN THIS SIDE FOR CONVENIENCE)

Fit Main End overlay to Van End with Eyo-Stick. Add Door Flaps into slots provided.

Form Door Stops & Solder into Slots Provided.



## Parts List

- Pre-Formed Body & Roof.
- Etchings.
- 4 Lengths Brass Aangle.
- Glazing.
- 24 Pins for Door Stops.
- 2 Screws/Nuts.
- Single Strand Wire - for Connecting ETH Terminals.

## Castings.

- 1 Set B.I Bogies
- 15 Roof Vents.
- 2 Vac Cyls.
- 1 Dynamo.
- 1 Switch-box
- 1 Regulator.
- 2 Air Brake Cyls.
- 1 Air Tank.
- 1 Distributor Valve.
- 2 Vac Pipes.
- 2 Steam Heat Pipes
- 2 Sets Air Pipes
- 2 Sets ETH Jumpers.
- 4 Buffers

Fit Hanger Steps - these are not fitted to all vehicles, though there seems no set pattern.

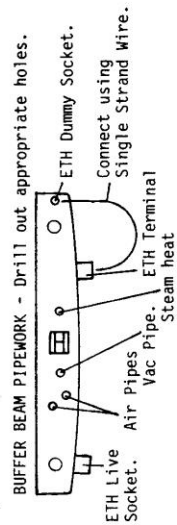

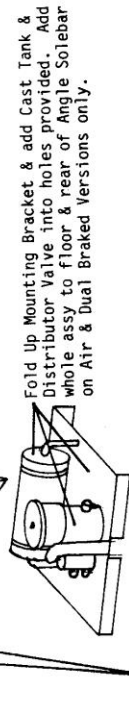
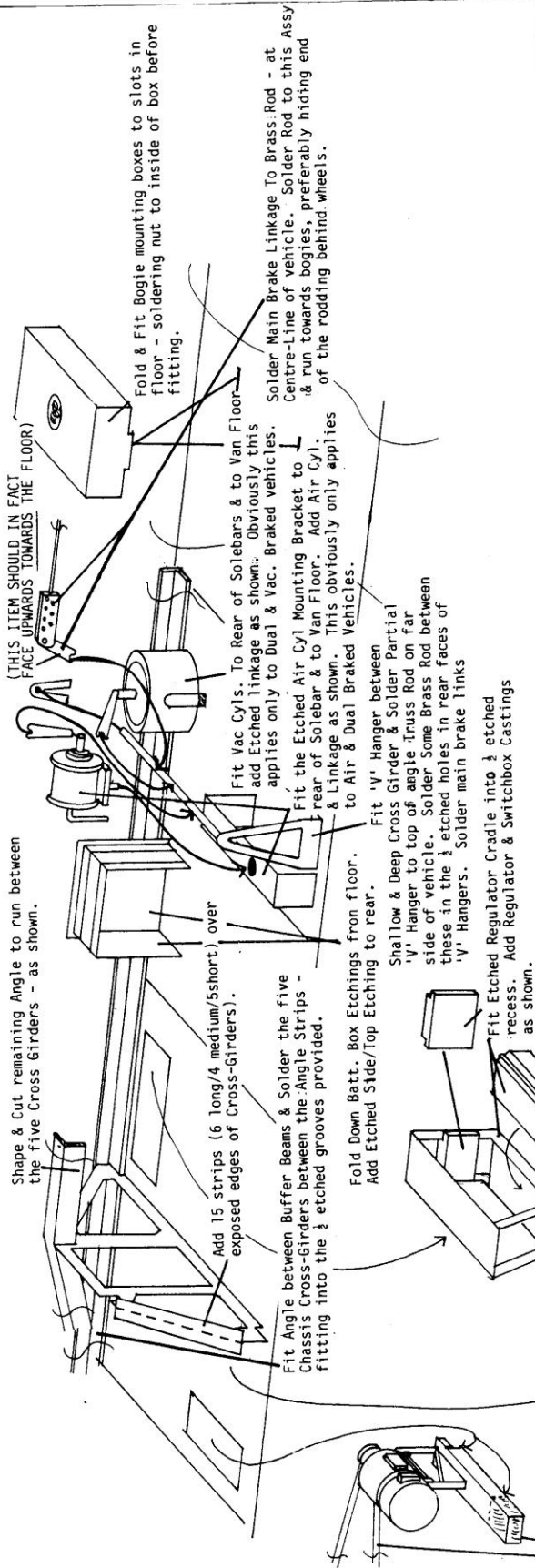

Fit Dynamo into 2 etched recess - cut 4.5mm off end of bottom bracket as shown. Add etched belt around pulley. This lines up with the turned pulley wheel on the Pemberton Wheelset - which should of course be used in the adjacent position.

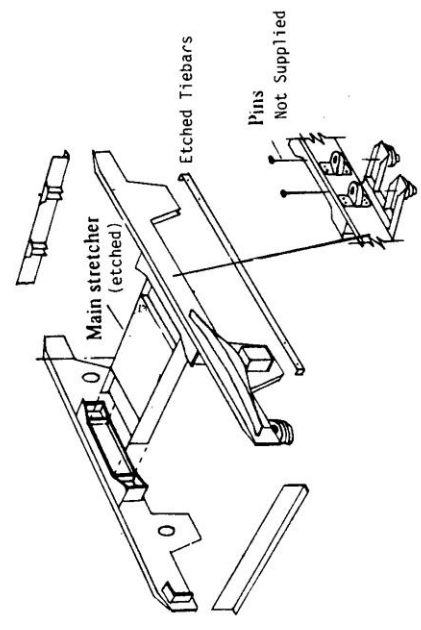

**fragile**

**Rail Express Parcels**